



ES-5000

User Manual



<Rev. 09-01-30>

Table of Contents

1. Introduction
2. Installation
3. Features
 - 1) Specifications
 - 2) General views
4. How to Operate
 - 1) Form Preparation
 - 2) Loading forms
 - 3) Start
 - 4) Fold Setting
 - 5) Operator Panel
 - 6) Manual Feed
5. Maintenance
 - 1) General Cleaning
 - 2) Paper Dust
 - 3) Cleaning Pickup and Fold Rollers
 - 4) Cleaning Press Rollers
6. Trouble Shooting
 - 1) Paper Jam
 - 2) Double Feed
 - 3) Mis-Feed
 - 4) Skewed Fold

1. Introduction

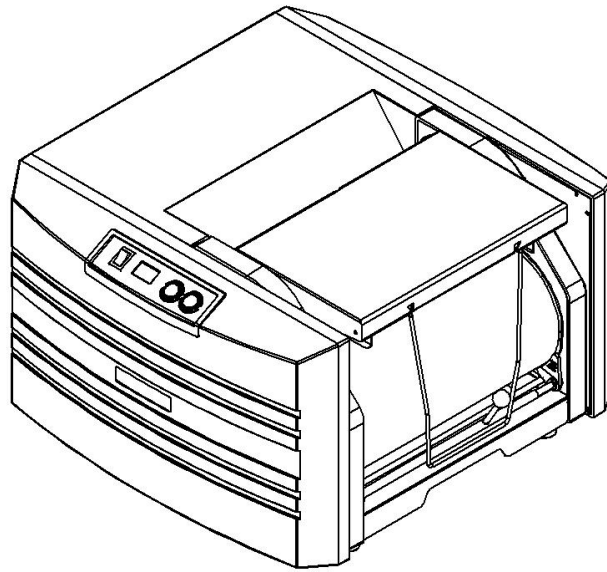

ES-5000 produces folded and sealed mailable documents with cut-sheet Pressure Seal forms. Pressure activated adhesive applied forms provide and instantly secure seal on all sides of the form, whether use a “C”, “V”, “Z” or “Double” fold.

Names of each part

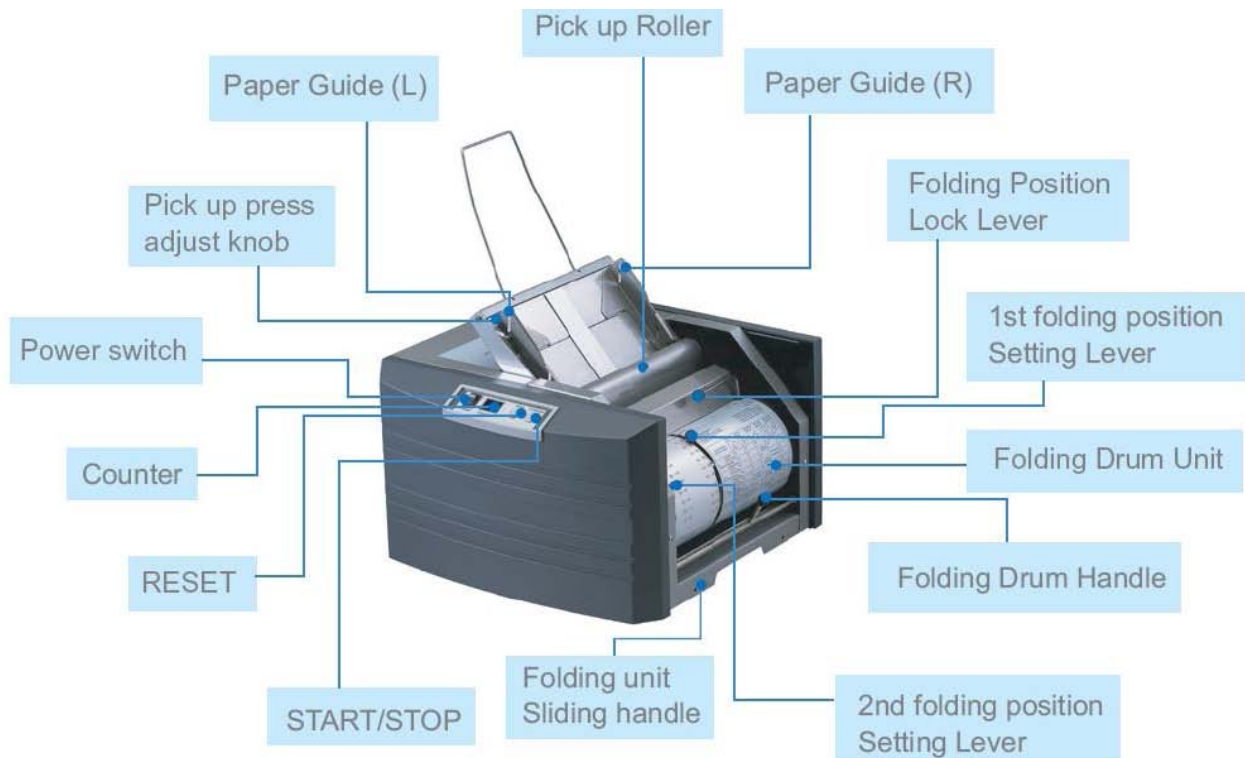

2. Installation

- Locate the box right next to the location where the machine will be set up and operate.
- Open Box, Remove the Operators Guide and set aside. Grasp the two Shipping Straps and remove the unit from the box.



- Remove all packing materials from around the unit and place the folder on a sturdy surface.
- Open Infeeder Chute and Pull out Paper Stopper



- Set up fold drum and run at least 50 documents through the machine. Show customer how to run the machine.

1) Features

1) Specifications

- Processing Speed 4,200 forms per hour
- Automatic jam recovery system
- No adjustment required for varying paper thickness
- Fold plate setting can be changed in seconds
- Manual feeder for single form processing
- Folding unit slides out for easy access and maintenance
- Digital reset counter
- Exceptionally quiet – approximately 45db
- Infeeder capacity-150(24#), 120(28#)
- Form Size: Letter, Legal(14" Z-fold available option)
- Z,C,V & double fold
- Paper Weights: 20 lbs. to 28 lbs.
- Counter: reset counter
- Jam Removal: folder unit slides out and opens
- Size: 17.3 x 16.5 x 19 inches (L x W x H)
- Weight: 80 lbs
- Power: 120V/60Hz

2) General Views

2.1) Folding Drum

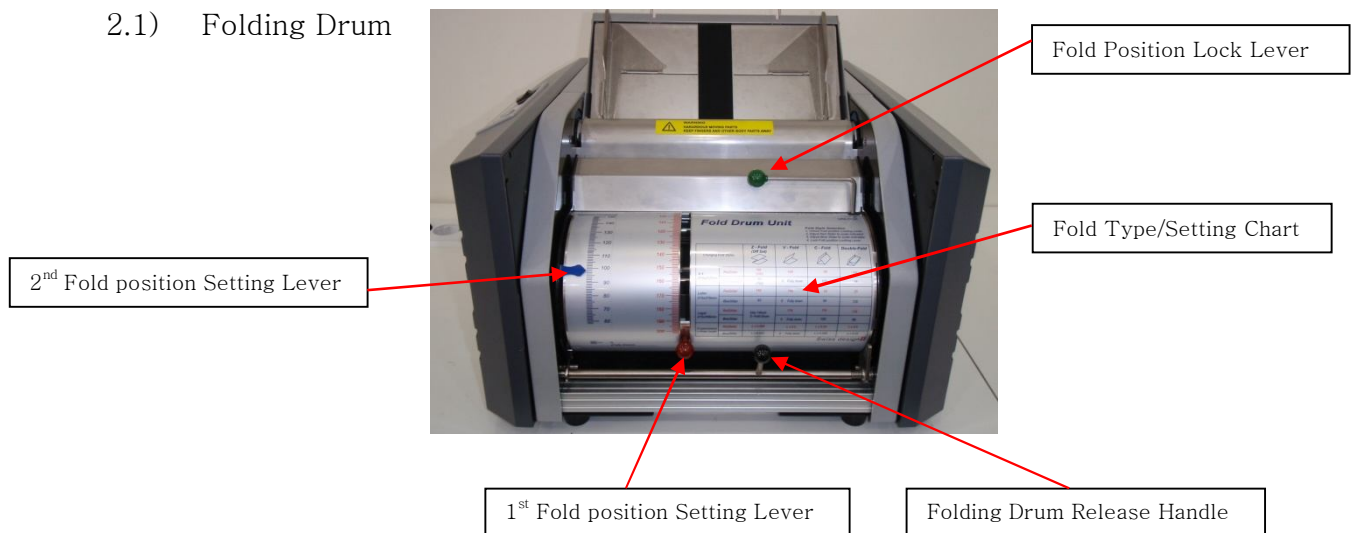

2.2) Feeding Unit

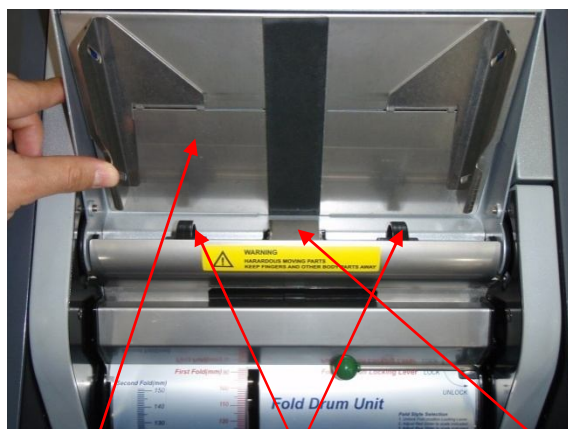

Spring-loaded Feed Table

Slide these Tab up or down to decrease or increase Feed Table spring lift tension to Aid in feeding documents. Factory Preset Value is right in the middle as shown above

2.3) Exit Tray

Stopper for Exit Tray

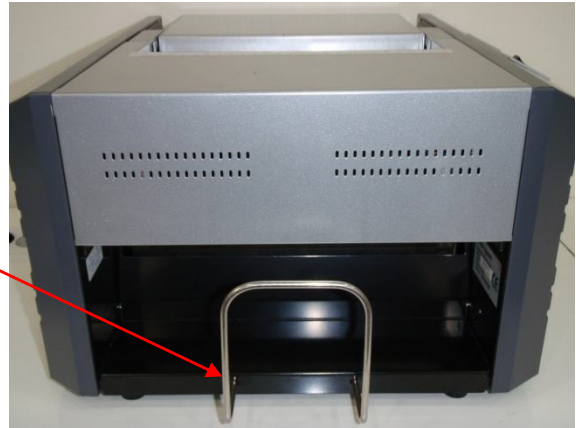

2.4) Label & Fuse



AC Socket



5 Amp 250V Mini Fuse in a 1/4 Turn Fuse Holder



Manufacturer's Label with Serial No.

2.5) How to Open the Fold Unit (Please follow the pictures below in order)

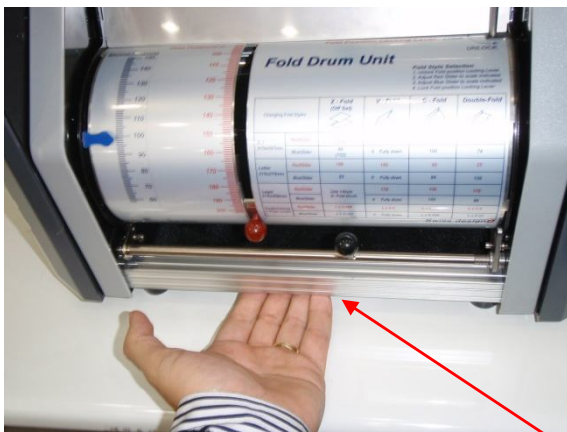

Folding Unit Pulls out by grasping the hand hold and pull out

2.6) How to open the Fold Drum (Please follow the pictures below in order)



Folding Drum handle in the Unlock(down) position

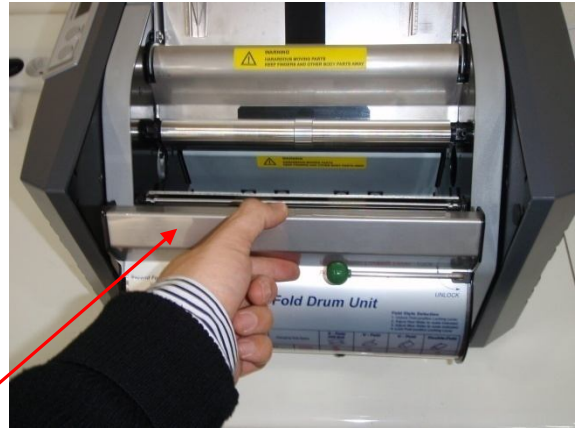

Folding Drum in the partially open position

Folding Drum in the open position. Access the Folding Drum for clearing jams



3. How to operate

1) Form preparation

Forms must be fanned properly on both sides to separate and eliminate any static that may have been induced by the laser printer

2) Loading forms

Place the paper in the Paper tray in the correct orientation as indicated in the chart below. The Paper tray can hold up to about 120 sheets of pressure forms. To correctly place your forms in the Paper tray, jog the forms so the stack is neat, push the Paper tray back so the forms will rest on the solid plate and behind the feed roller. The Paper tray is spring-loaded to apply the correct amount of pressure for proper feeding.

It is always a good idea to fold one form to verify that the fold settings are OK and have not been changed. Adjust if necessary and then proceed to load your forms in the Paper tray.

Form	Load in Paper tray	Forms will deliver
Z-Fold	Address leading, Face Up	Address side will be face up and document sequence will be reversed from the sequence in the Paper tray
Z-Fold	Address Trailing, Face Down	Address side will be face down and document sequence will be reversed from the sequence in the Paper tray
C-Fold	Address Trailing, Face Down	Address side will be face up and document sequence will be the same as the sequence in the Paper tray
V-Fold	Address Trailing, Face Down	Address side will be face down and document sequence will be the same as the sequence in the Paper tray

3) Start (Press Start button to fold & seal)

3.1) If the output is acceptable, Run the job

3.2) If the folded position is not correct, reset the fold position by readjusting the fold guide.(Please use plain paper for a test run in order to find out more accurate the fold position and compare the folded position with the perforation line on the forms)



4) Fold Setting

4.1) Standard Folding Drum



- 4.1.1) Unlock the green release lever to set the fold position
- 4.1.2) Move the red arrow, First fold on the red knob to the fold position required according to the manual on the fold drum
- 4.1.3) Move blue arrow, Second fold according to the manual on the fold drum
- 4.1.4) **Once the fold position properly is done, lock back the green release lever** (Red knob is the first fold setting, Blue knob is the second fold setting)

Ex 1) “Z” fold with 8 1/2" x 11"

- Red knob “186”(First fold 186mm), blue knob “93”(Second fold 93mm)

Ex 2) “C” fold with Letter

- Red knob “92”(First fold 92mm), blue knob “94”(Second fold 94mm)

Ex 3) “V” fold with 8 1/2" x 11"

- Red knob “140”(First fold 140mm), blue knob “0”(Fully down, No Second fold)

Note: Please note that although we suggest that you follow the fold setting according to the manual, however the scale on the drum is NOT 100% accurate

Pressure Sealer ES-5000

5) Operator Panel

- 5.1) Power Switch: Power On/Off
- 5.2) Reset: Reset button will clear the display count
- 5.3) Start/Stop: Start/Stop button will start or stop the Feed cycle
- 5.4) Counter: Display will show the total page count/resettable as well as Firmware Rev. Level at Start-up, Fold unit open and Jam condition, please see the pictures as below for the details

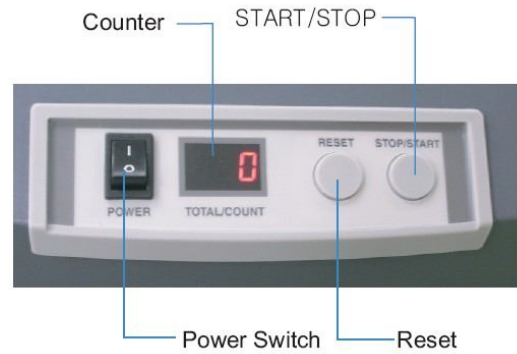

During operation the display will show the number of forms processed. This number can be reset to 0 by pressing the reset button on the op panel

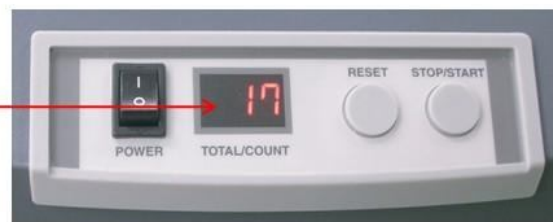

When the unit is separated the display will show OPN



In case of a paper jam on the out-feed the display will flash repeatedly. Press the start / stop button to stop this after you have removed the paper jam



6) Manual Feed

- 6.1) Fold the form manually and insert the form to the manual feeder
- 6.2) Press Start button to run the machine

Note: This is ideal for the poorly sealed forms owing to evaporation of the glue



5. Maintenance

1) General Cleaning

Be sure that the room is well ventilated, Switch off the mains power and unplug or disconnect from the mains, Pull out the fold drum and the fold unit, Remove as much paper dust as possible using a soft brush



2) Paper Dust

With general use, paper dust will build up inside the machine and can be cleared by using an can of invertible Air Duster, which will apply a short burst of compressed air and clear any paper dust that may be present.

3) Cleaning Pick up and Fold rollers

Clean the pickup roller, aluminum and rubber roller in the Fold unit with roller cleaning fluid such as an alcohol solution.

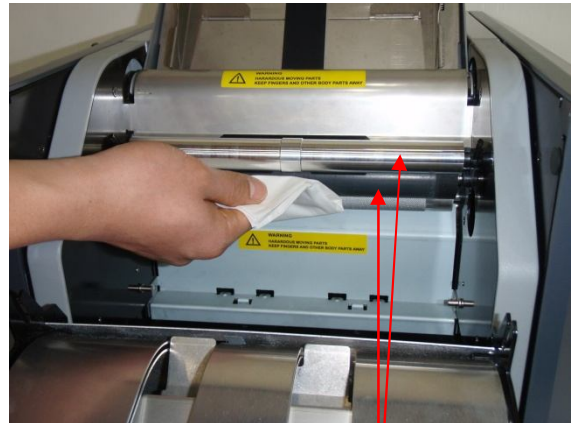
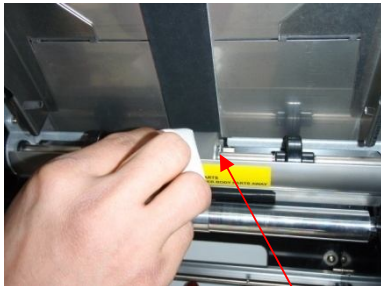

Pickup roller in Gray color

Aluminum & Rubber rollers

Caution:

Please do not use any gasolinic oils since it may damage the surface of the rubber rollers!

Avoid breathing the fumes or getting the solution in an open wound or other sensitive areas such as the eyes or mouth!

4) Cleaning Press Rollers

With general use, toner will build up on the Press rollers. Check the rollers for build up and clean on a regular basis with roller cleaning fluid. Depending on the type of laser printer, toner and fuser, the degree of build up will vary.



Clean both Upper & Lower Press

6. Trouble Shooting

1) Paper Jam

1.1) Feeding Unit Jam

Do not pull the document backward in the event of jam in the Infeeder.

Open the Fold Drum Unit by pushing down the Fold Drum handle as the direction of the red arrow in the picture on the right



Pull the paper to the direction of the red arrow as shown in the picture on the right



1.2) Folding Unit Jam

Open the Fold Drum Unit by pushing down the Fold Drum handle as shown in the direction of the red arrow in the picture on the right



Remove the document from the Folding Drum as shown in the picture on the right



- 1.3) Press Unit Jam
Fully extend the Folding Unit to the direction of the red arrow in the picture on the right



Use the Jam Removal Tool to rotate the rollers by placing the tool into the jam Removal holes as shown in the picture on the right



Turn it downward. Remove the jam as shown in the picture on the right
Tips: Correct any mis-folds and run the form through the manual feed (please refer to Chapter 4-6 for the details of the manual feed)



- 1.4) Out Feed Jam
In the event of jam in the Out-feed, the display blinks

Push down the lower plate (with the rollers) and remove the jam as shown in the picture on the right.



2) Double Feed

- 2.1) Clean the Pickup rollers and pad with an alcoholic solution(In case the problem persists, then go to 2.2)
- 2.2) Slide In-feed tray tension adjusters upwards (Manufacturer's default position: middle). Both tension adjusters must be in the same position as shown in the picture on the right(In case the problem persists, then go to 2.3)
- 2.3) Replace in-feed roller and or Separator(Pad Base)

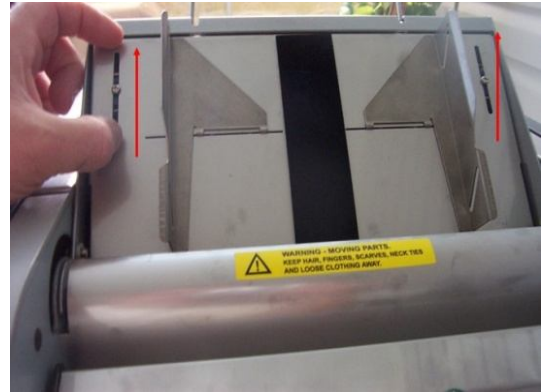

3) Mis-Feed

- 3.1) Clean In-feed roller and pad with an alcoholic solution(In case the problem persists, then go to 3.2)
- 3.2) Move the In-feed tray tension adjusters downwards until miss-feeding is resolved as shown in the picture on the right(in case of no improvement, then go to 3.3)
- 3.3) Replace in-feed roller and/or Separator (Pad Base)



4) Skewed Fold

- 4.1) Clean the In-feed roller and pad with an alcoholic solution
- 4.2) Check to make sure the side guides are not bent in any ways
- 4.3) Insure that there shouldn't be too much gap between paper and the side guides as shown in the picture below



- 4.4) On adjustment screws are set correctly
- 4.5) Insure that the side guides are right up against the edge of the form but not compressing the form
- 4.6) Look for foreign materials in the folding drum assembly

- 4.7) Clean the fold rollers with an alcoholic solution
- 4.8) Examine and replace any folding roller with imperfections such as flat spots or swelling
- 4.9) Replace or exchange from side to side the folding roller compression springs



Division of Pai Trading, Inc.
Headquarters & Factory
15951 SW 41st Street. Suite 400
Davie, FL 33331
Email: paitec@paitec.com
www.paitec.com

Size and Fold Type	ES5000 - IM4000 - IM9500						ES2000 - ES7000 - MX6000 - MX8000			
	Drum		First		Second		First		Second	
	CV	Z	mm	inches	mm	inches	mm	inches	mm	inches
11" Z-Fold	X	X	186	7-1/3	93	3-2/3	93	3-2/3	93	3-2/3
14" Z-Fold		X	237	9-1/3	118	4-2/3	118	4-2/3	118	4-2/3
14" EZ-Fold *		X	222	8-3/4	133	5-1/4	133	5-1/4	133	5-1/4
11" C-Fold **	X		92	3-5/8	94	3-11/16	188	7-3/8	94	3-11/16
14" C-Fold ***	X		<i>Note: there are no standards for this format, measure your form for settings</i>							
14" EC-Fold ****	X		86	3-3/8	135	5-5/16	270	10-5/8	135	5-5/16
11" V-Fold	X		140	5-1/2	0	0	140	5-1/2	Use V-Insert	
14" V-Fold *****	X		178	7	0	0	178	7	Use V-Insert	

Fold Type

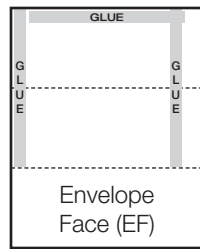
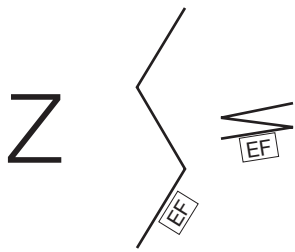

To Identify Fold Position Number and Feed Direction			
ES5000 - IM4000 - IM9500		ES2000 - ES7000 - MX6000 - MX8000	
Fold #	Feed Direction	Fold #	Feed Direction
1st Fold	↓	1st Fold	↑
2nd Fold		2nd Fold	

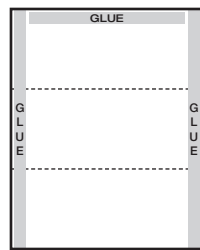

Fold #	Feed Direction	Fold #	Feed Direction
1st Fold	↓	1st Fold	↑
2nd Fold		2nd Fold	

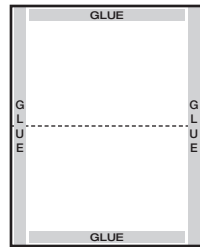
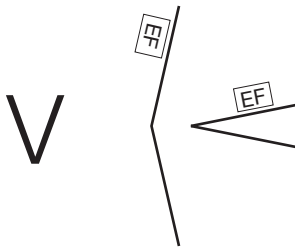

Fold #	Feed Direction	Fold #	Feed Direction
1st Fold	↓	1st Fold	↑

EF = Envelope Face

* Indicated settings are for the standard 14" EZ-Fold with two 5.25" and one 3.5" panels.
 ** These settings are for a correctly mfg'd 11" C-Fold form. The inside panel is shorter than the outside panels to avoid jamming during folding.
 *** Rarely used, please measure your form as there is no standard for this size and format.
 **** Settings are for the 14" C-Fold form that creates a reply envelope when folded and sealed. Other configurations will vary.
 ***** Not commonly used as this size will require additional postage if mailed

Folding Diagram

C & V Fold Drum

Z-Fold

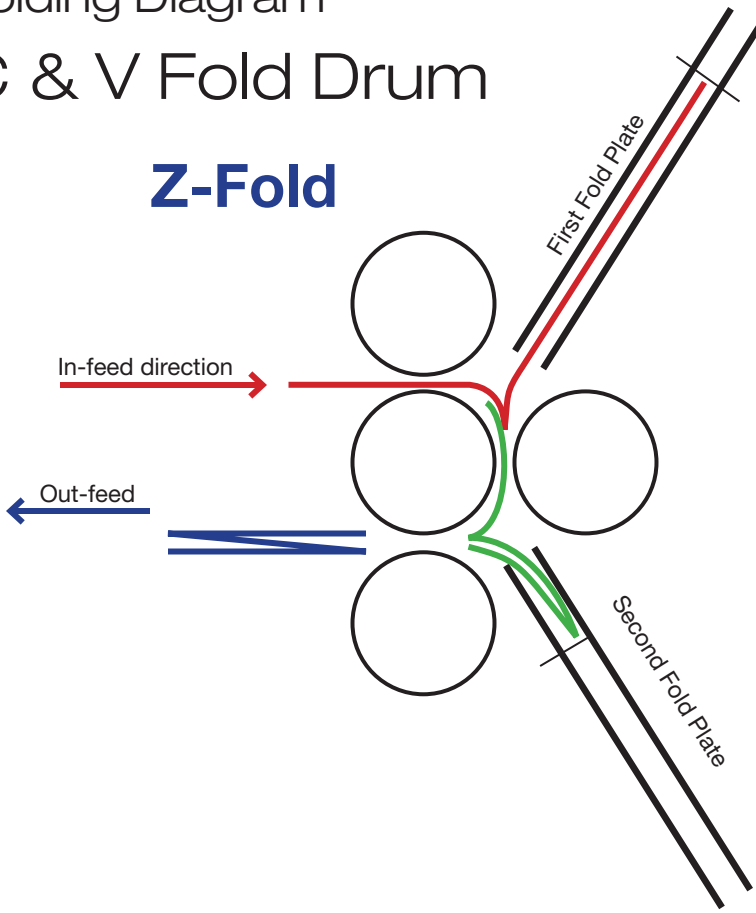

V-Fold

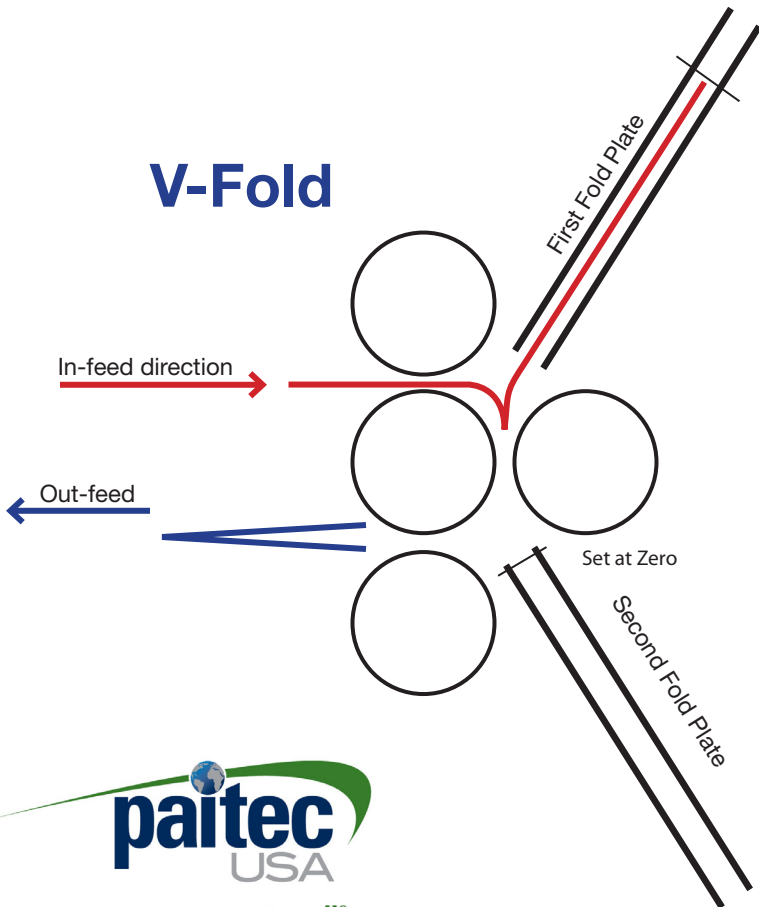

C-Fold

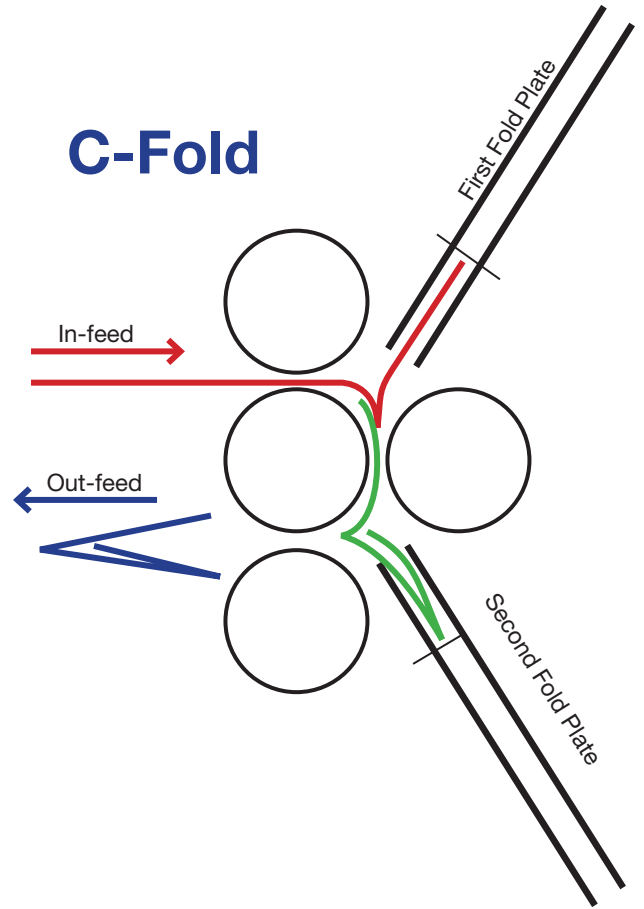

ES5000

IM4000

IM9500

Fold Plates	1st Fold	2nd Fold
Minimum	73 mm 2.875 in	0 mm 0 in
Maximum	220 mm 8.667 in	150 mm 5.9 in

Symmetrical Fold	1st Fold	2nd Fold
Z-Fold	2/3	1/3
V-Fold	1/2	None
C-Fold	1/3	1/3
Double Parallel	1/2	1/4

Folding Diagram

Z Fold Drum

ES5000L

IM4000L

IM9500

Z14-Fold

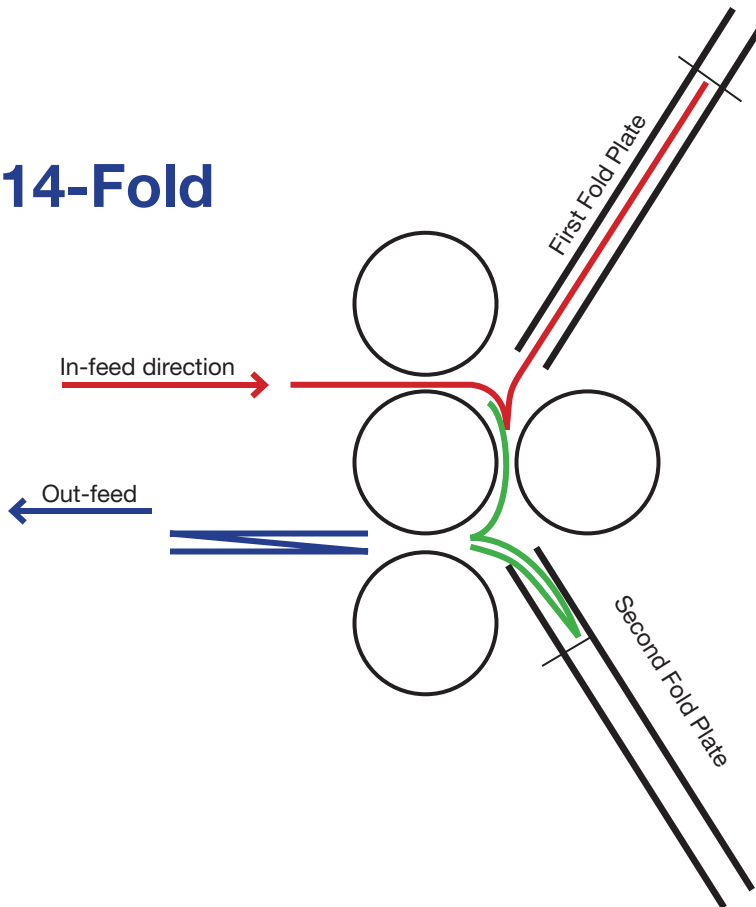

Fold Plates	1st Fold	2nd Fold
Minimum	181 mm 7.25 in	79 mm 3.1 in
Maximum	238 mm 9.33 in	140 mm 5.5 in

Z-Fold	11" = Z	14" = Z	14" ≠ Z
1st Fold	186 mm	237 mm	222 mm
2nd Fold	93 mm	119 mm	133 mm

Z Fold Drum Settings

By looking at the Customer's Form, determine the Size of Paper and Type of Fold. The **blue** slider on the front of your drum is your first fold position marker (There are basic instructions on the drum to help you.) Remember unlock the **first fold locking lever** (Green plastic ball on shaft) first before moving the blue slider

Fold Position locking lever



First Fold slider

Fold Drum locking lever release this to access the second fold plate.

Z Fold Drum Settings Cont....

The second fold position is located inside the drum. Unlock the fold drum release lever (this has a black plastic ball on the shaft) the drum will drop forward. Now you can see the second fold plate and settings... You must loosen the 2 thumb screws to move the slider to the required setting.

Thumb Screws

