

Akiles Diamond 6 Operation Manual

OPERATIONAL MANUAL

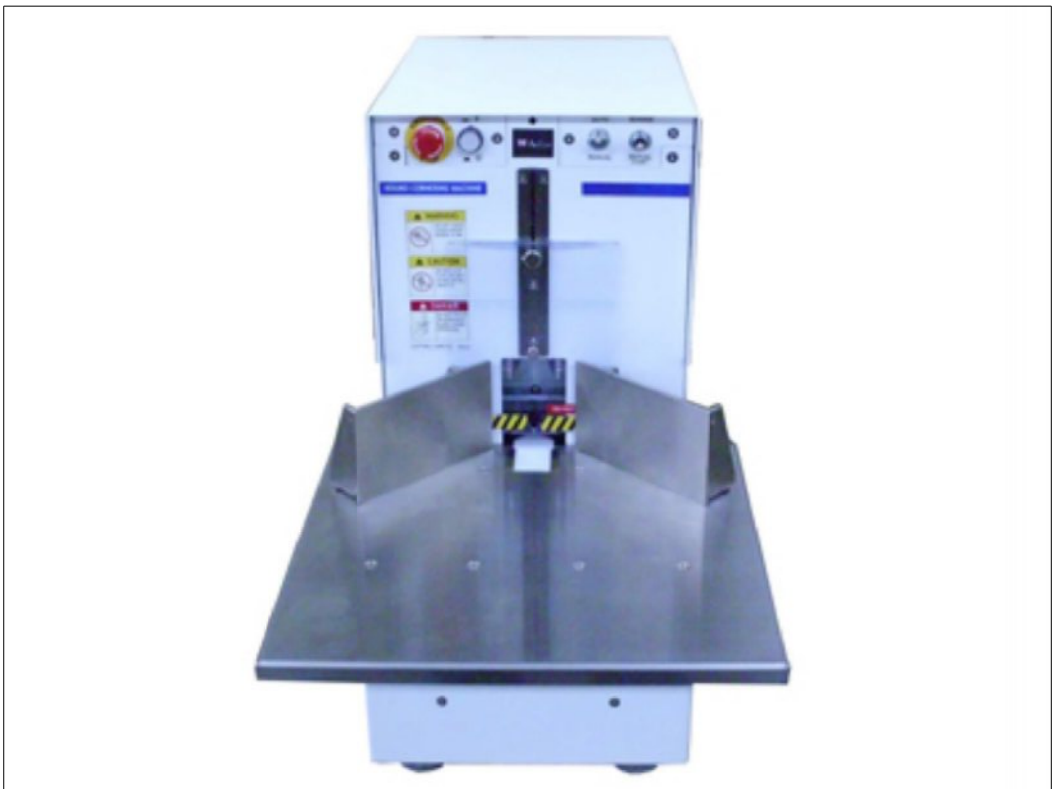

ITEM NO: AD-6

A. Name of machine parts2

B. Safety instructions3

C. All kinds of blade

 ① Upper blades..... 3

 ② Lower blade pads 3

D. Standard parts & accessories4

E. Optional parts & accessories4

F. Machine operation

 ① Installation and cutting test5

 ② Right and left side guide adjustment

 a. Without calibrate gauge 7

 b. With calibrate gauge 8

 ③ Changing blades

 a. Changing the upper blade 8

 b. Changing the lower blade pad 9

 c. Changing the blade base 9

 d. Changing the straight blade C1510

 ④ How to use the "L" guide10

G. Maintenance

 ① Changing fuse and discharge capacitor 11

 ② Lubrication applying 11

 ③ Blade sharpened 12

H. Electronic control system

 ① Electrical drawing..... 13

 ② Position chart 14

I. Diagram and parts list

 ① Machine main structure 15





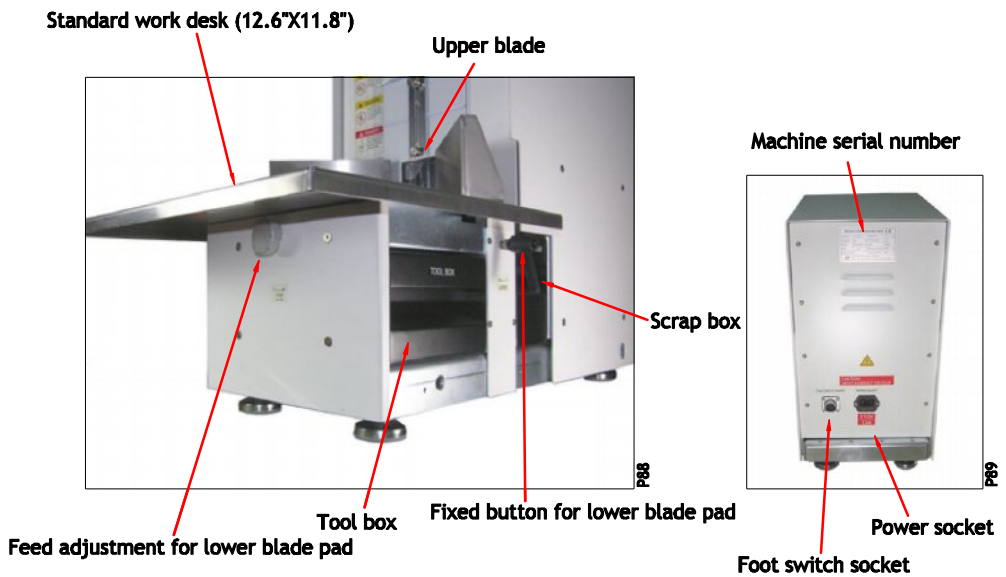
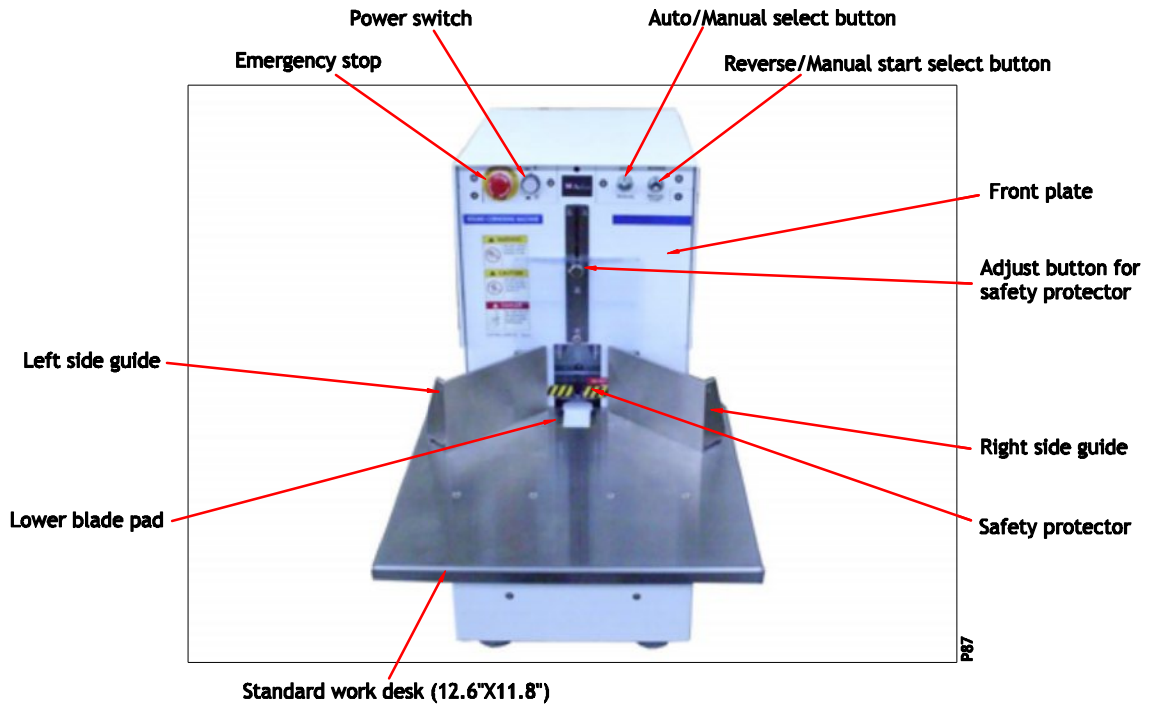

 ② Parts of structure: Main shaft system and Lower blade system 17

 ③ Screws and other standard hardware parts list 19

A. Name of machine parts



B. Safety instructions **(Before setting up the machine, carefully read all the manual)**

	Make sure the outlet with the correct volgate and type
	Blade is sharp, non-operator please keep away from machine.
	Do not put fingers into the safety protector during operating time.
	Do not cut staples, paper clips and other metal objects.
	Always turn off power when changing blade.
	Always turn off power when work completed.

C. All kinds of blade

① Upper blades (3 radius upper blades, 1 straight blade, total 4 kinds)



AD6-K3.5
Upper blade
Size:R1/8"



AD6-K6
Upper blade
Size:R1/4"



AD6-K10
Upper blade
Size:R 3/8"



AD6-C15
Straight blade
Size: 5/8"

② Lower blade pads (straight blade can be with any kinds of lower blade pad)



AD6-K3.5-2
Lower blade pad
Size:R1/8"



AD6-K6-2
Lower blade pad
Size:R1/4"



AD6-K10-2
Lower blade pad
Size:R 3/8"

D. Standard parts & accessories (total 8 parts)

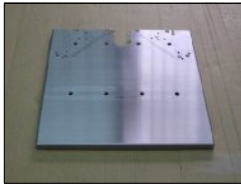

Standard work desk - 1 pc
Size: 12.6" X 11.8"



Left and right side guide -
each 1 pc



Tool and scrap box - each
1 pc



Maintenance tools:
1. Cross-head and flat-head
screwdriver - each 1 pc
2. T-type hex wrench (2.5,3) -
each 1 pc
3. Hex wrench (1.5/2/2.5/3/4)
- each 1 pc
4. Fuse (4A) - 5 pcs



Maintenance screw set
1. Round-head hex screw(M4X8) - 5 pcs
2. Flat-head hex screw(M4X8) - 10 pcs
3. Truss-head cross screw(M4X8) - 5 pcs
4. Socket-head hex screw(M4X12) - 4 pcs
5. Washers (Ø4X2t) - 4 pcs



Operational manual - 1 book



1. 1/4" upper blade - 1 pc
2. 1/4" lower blade pad - 10 pcs
3. 1/4" blade base - 1 set



Safety protector - 1 set

E. Optional parts & accessories (total 8 parts)

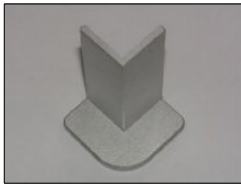

L guide



Straight blade
Size: 5/8"



Straight blade base



Upper blade
Size: 1/8", 1/4", 3/8"



Blade base
Size: 1/8", 1/4", 3/8"



Lower blade pad
Size: 1/8", 1/4", 3/8"

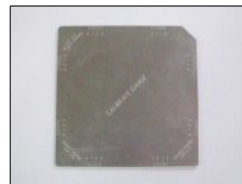

Calibrate gauge



Oil stone
Size: 8" X 2" X 1"

F. Machine operation

CAUTION: Before operating machine, carefully read all the manual

① Installation and cutting test



P91

Place machine on top of a sturdy work table.

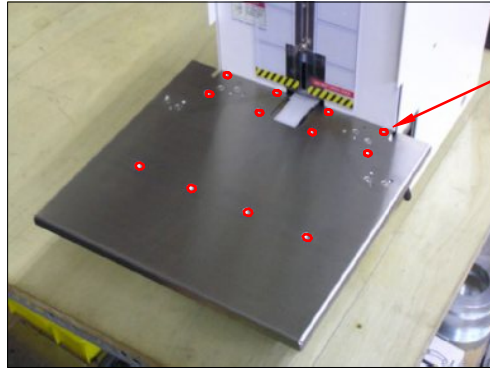

P92

12 mounting holes

Place the work desk onto the machine as shown. Align the machine screw holes to the 12 mounting holes as arrows indicate.



2.5mm hex wrench

P93

Take the 2.5mm hex wrench, fasten the 12 pcs flat-head hex screw(size: M4x8).

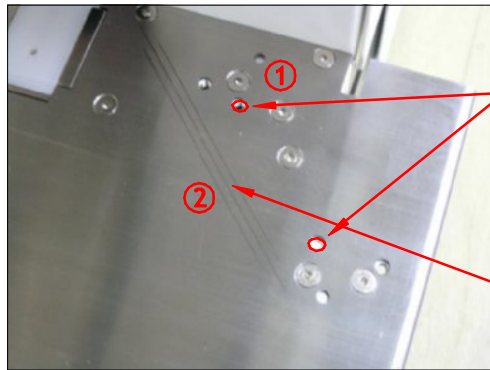

reference line 2 holes for right side guide

As arrow ① shown the 2 holes are for right side guide hole.

② shown the reference line for the right side guide place and adjust the reference.



right side guide

3mm hex wrench

P94

Place front edge of the right side guide on the central reference line, target the 2-hole shown in P40 on the fixed holes.
Use 3mm hex wrench lock the M4X12 socket-head hex screw.
Fixed left side guide same as above.

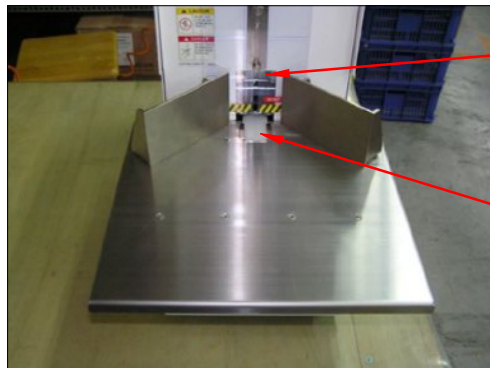

upper blade

lower blade pad

P95

Above figure show the ready position for right and left side guide.

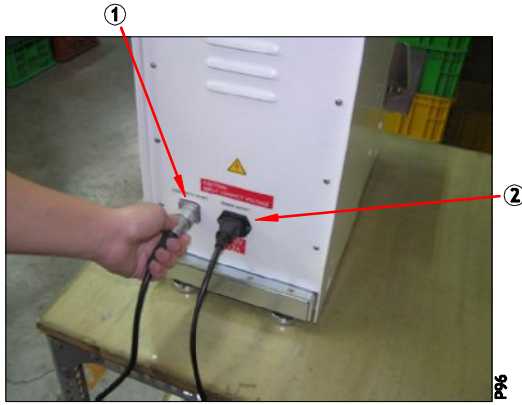

(Attention: Make sure the correct voltage)
 Plug foot switch cord ① into the socket, then power cord ② into the socket.

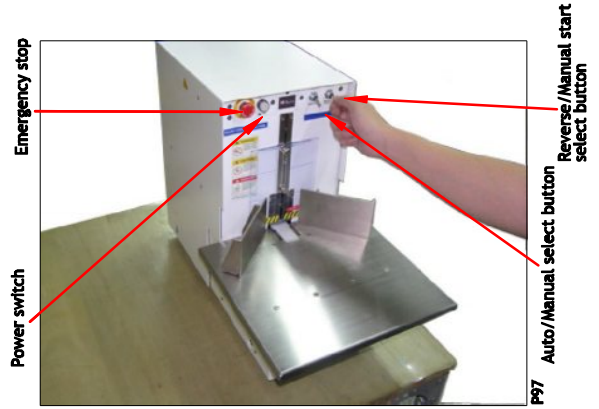

1. Turn on the power switch motor is standby, the light is on but motor not rotation.
2. Turn the operation mode to manual.
3. Push-down manual start button, push-down to start release to stop motor, make upper blade slowly down intermittently touch the lower blade pad, check blade if ready for working. (blade has been calibrate by original)



1. Turn the operation mode to auto. (for manual mode, leave the upper blade slightly off the top position, and step on the foot switch to start)
2. Test with the foot switch see if normal operation. (push-down the switch to finishing a cycle, release the foot switch then start again)



Put one sheet of paper close to right and left side guide. (Keep finger out of safety protector) Step the foot switch for cutting testing.
 (When the upper blade to rise up, if heard a sharp noise. Can be add a little lubricating oil on upper blade's flank then dried to resolve the noise.)



Check if the corner rounder is tidy or any cutting edge remain. If yes, make a new lower blade pad cutting is requested. How to operate as shown P50-P51.



1. Release the fixed button of lower blade pad counter-clockwise.
2. Fixed button can be pulled out and turn around to change position. Adjusted to the best position between scrap box and tool box.
3. To lock, hold the handle while rotating clockwise and inward to press.

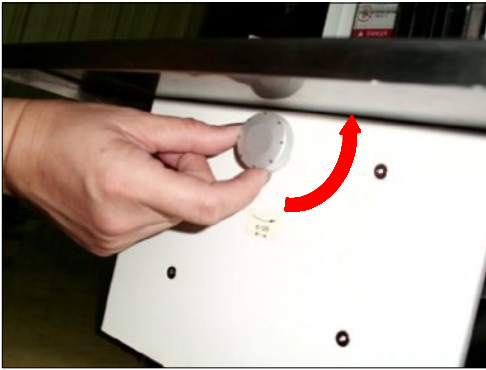

Turn counterclockwise one section of feed adjustment as shown, the lower blade pad will move 0.125mm. (one time one section can get better incision) Then lock the fixed button and try cutting again, if the situation remains the same, please repeat P50-P51. (a lower blade pad can be use 80 sections)

② Right and left side guide adjustment
a. Without calibrate gauge

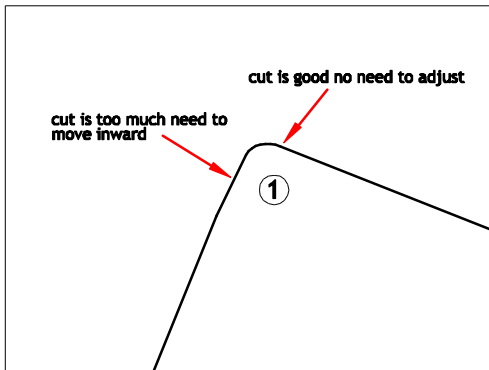

Above shown the right side cut is good no need to adjust. Left side cut is too much need to move inward of left paper guide.

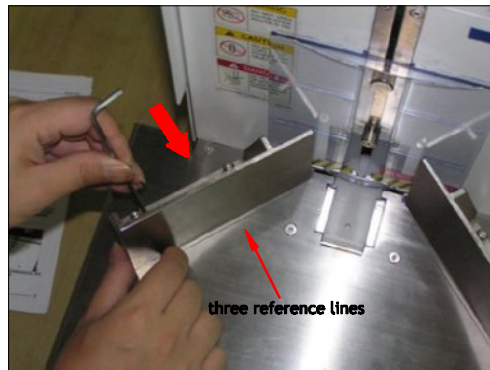

Release 2 fixed screw on left side guide. Refer the three lines on work desk, ① arrow is the direction of inward movement, keep front edge of the left side guide and reference line are parallel then fixed it for once cutting. If the situation remains the same, please repeat above procedures unit get perfect corner rounder.

b. With calibrate gauge

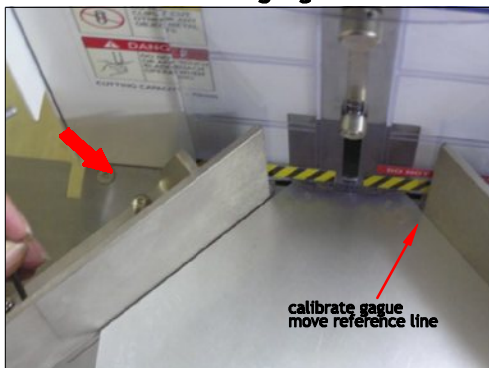

Keep calibrate gauge close to right and left side guide. Check the relative position between calibrate gauge and right side guide, micro adjustment the calibrate gauge to right as red arrow shown. Hold the gauge with right hand and loosen the 2 pcs fixed screw of left side guide by left hand, then move the left side guide close to calibrate gauge and fixed tightly.

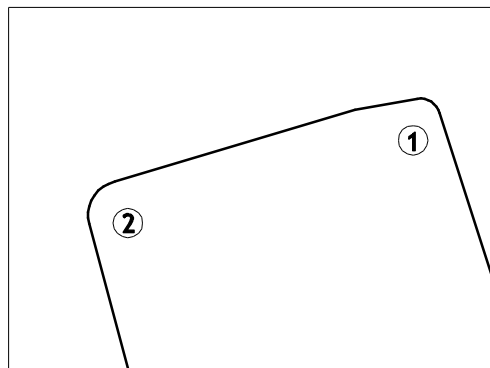

As drawing ① shown the left cut is too much need to adjust left side guide to right. Drawing ② is the perfect cutting after adjustment.

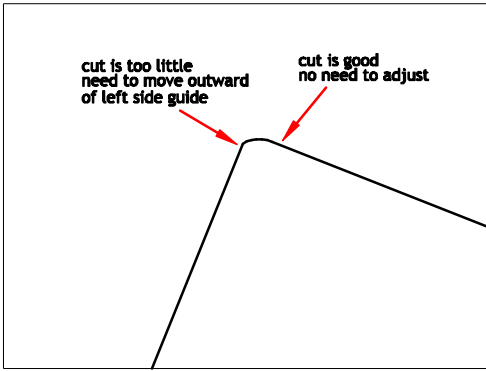

As drawing shown left cut is too little need to move outward (to left) of left side guide.

③ Changing blades

a. Changing the upper blade



1. Turn off the power.
2. Remove the front plate.
3. Take 2.5mm T-type hex wrench, counterclockwise loosen 4 pcs of fixed screw.

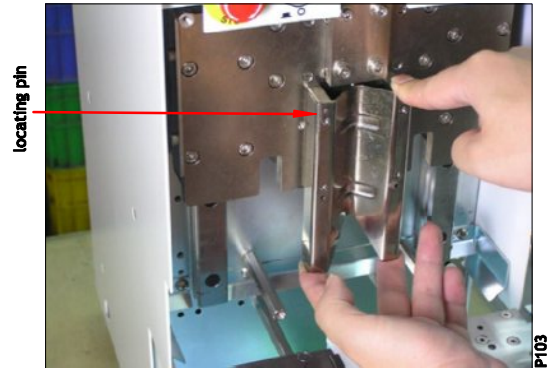

Caution: V-type blade is sharp, do not touch with fingers.

As shown use left hand two finders hold on bottom of upper blade, and hold the top with right hand index finger, slow-shake to remove the blade out. Same as above take a new blade, aligned and press inward to the 2 locating pin as arrow shown. Take 2.5mm T-type hex wrench to lock the 4 pcs screw. (Please check again for well looking)

b. Changing the lower blade pad (3 upper blade with 3 lower blade; Ex: K6 lower blade with K6 upper blade)



Turn off the power, release the fixed button of lower blade pad counterclockwise.



As photo shown, rotate the feed adjustment in a clockwise to the end.



Take screwdriver to get bottom-under the lower blade pad, forward the pad to scrap box.



Take short-side of 3mm hex wrench and push inside to new lower blade pad hole for fixing(as shown), then take hex wrench align to the guider and push down until touch to the end. Then take the hex wrench out and lock the fixed button of lower blade pad.

c. Changing the blade base



Attention: Turn off the power first

1. Blade base corresponding to upper blade, Ex: K6 blade base use for K6 upper blade.
2. Take 2.5mm hex wrench to loose 2 pcs of fixed screws.

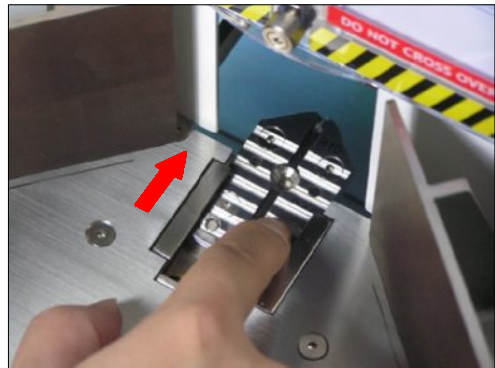

Use finger push and forward the blade base to scrap box and take the base out.



Take the new base, install the base plate from the front and pull back to the end, not lock now.



1. Install the front plate.
2. Turn on the power and keep manual button, Use manual start button operation and stop upper blade on lowest point.
3. Turn off the power and remove the front plate.
4. Push and forward the blade base align with fixed hole. Check if enough security gaps between upper blade and blade base before fixing. (Please check again for well locking)

d. Changing the straight blade C15



P110

1. Turn off power and release the front plate.
2. Use left hand's hold upward the white protector to the base and close to the positioning plate, right hand take 3mm T-type hex wrench and screw tightly the 2 pcs of M4X16 screws, make sure fasten tightly.
3. Remove the white protector, and replace front plate. The C15 blade is now complete.



P65

1. Picture shown how to change new C15 blade.
2. First, put on the white protector on used blade, take 2.5mm T-type hex wrench to remove the 4 pcs fixing screws.
3. Same, put on the white protector on new blade before changing. Replace it on blade base then 4 pcs of fixing screw, make sure screws fasten tightly.

④ How to use the "L" guide



P111

Adjust the safety protector and keep stack of paper about 5mm height distance, fix the adjust button.



P112

Put the "L" guide on table, use "L" guide left and right edges to tap the stack of paper in parallel till paper is neatly. At the same time, make sure "L" guide close to the outside corner of the paper. Right hand fingers hold "L" guide at the bottom(as shown), slightly press the "L" guide let it close to the paper for cutting.

G. Maintenance

① Changing fuse and discharge capacitor



P75

Replace the fuse

1. Unplug the power cord.
2. Take flat-head screwdriver, pry-open the hole as picture shown outward, pull out the fuse holder by another hand.
3. Remove the damaged fuse and replace a new one that meet the specification, then re-plug the power cord for using.



P76

Before disassembly the circuit, user must to discharge the capacitor's surplus electricity. And pay attention fingers do not to touch the metal part when using the screwdriver.

1. Use the flat-head screwdriver pry open the cover of the terminal blocks.
2. Use the cross-head screwdriver to hold the M5 junction of the screw, and use flat-head screwdriver to hold the M6 junction of the screw, then move both screwdriver to touch. At same moment will have sparkles caused from the touch.
3. After disassembly, replace the cover of the terminal blocks.

② Lubrication applying (Refuel lubricant every 30 days for using frequently. for not often use every 90 days)

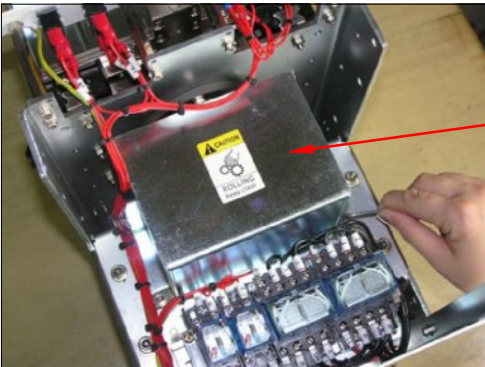

gear protector cover

P77

1. Turn off power, unplug the power cord.
2. Remove the 10 pcs screw of outside the shield, both hands hold the shield and move upward slowly.
3. As shown remove the 2 pcs screw on gear protector cover.
4. Move the gear protector upward slowly.

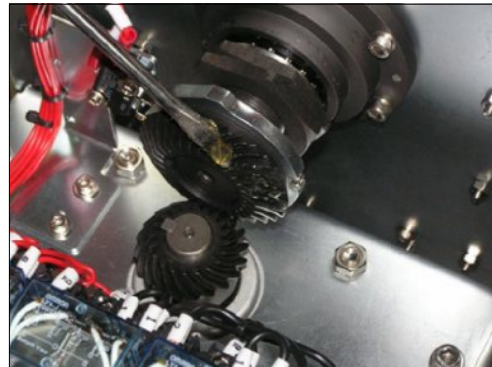

P78

As shown smear a little grease lubricant on bevel gear, then covered the gear protector cover by the 2 pcs fixing screws and fasten tightly.

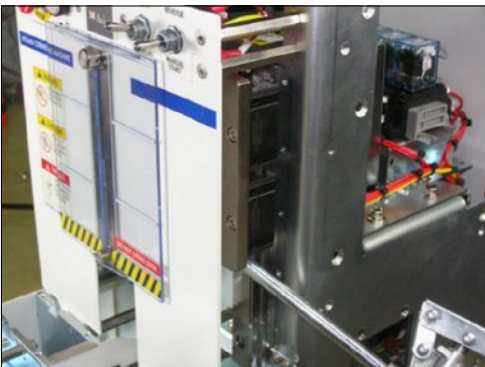

P113

As shown is the lubricating linear slider(2 sliders each left and right), carefully press a little grease lubricant by grease nozzle into the sliders.

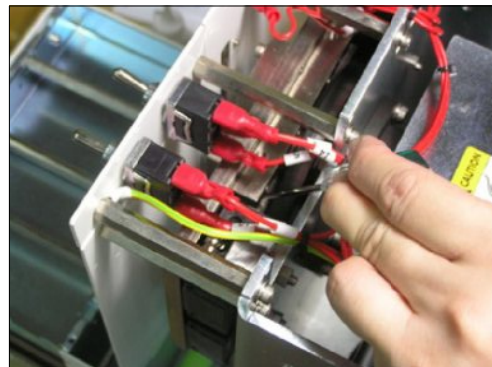

P114

As shown is the cam track for lubrication, take few lubricant by flat-head screwdriver and spread lubricant on both sides of cam track.



P115

- P84/P115 is shown how to lubricating for blade pad system
1. Remove the left and right side guide and work desk.
 2. Lubricate the movement blade pad feeding device.

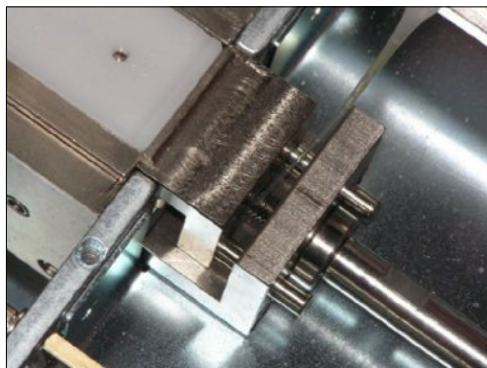

P84

As shown lubricate the feeding thread and shaft, apply with a little lubrication while rotating.



P85

As shown when the scrap box accumulated up to seven full please empty the scrap, in order to prevent the risk when upper blade work down cutting.

③ Blade sharpened (K3.5/K6/K10 upper blades and straight blade are all available to sharpen by oil stone)



P86

Blade is sharp, do not touch with finger.
As shown put radius V-shaped blade on the oil stone. Add a little lubricate on the oil stone, smooth moves back and forth sharpened blade.
For straight blade, same operation as radius blade.

H. Electronic control system (110V)

① Electrical drawing

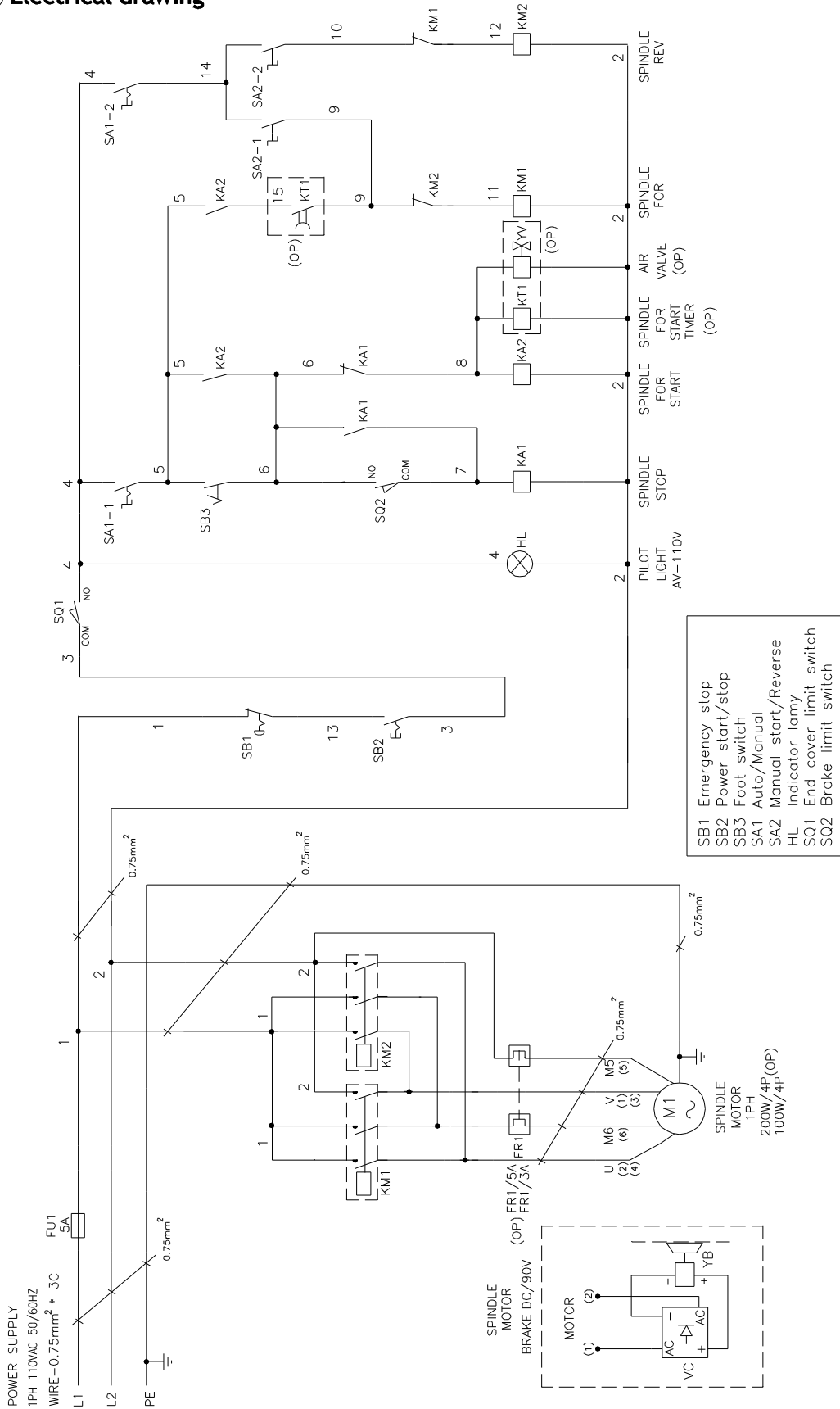

② Position chart

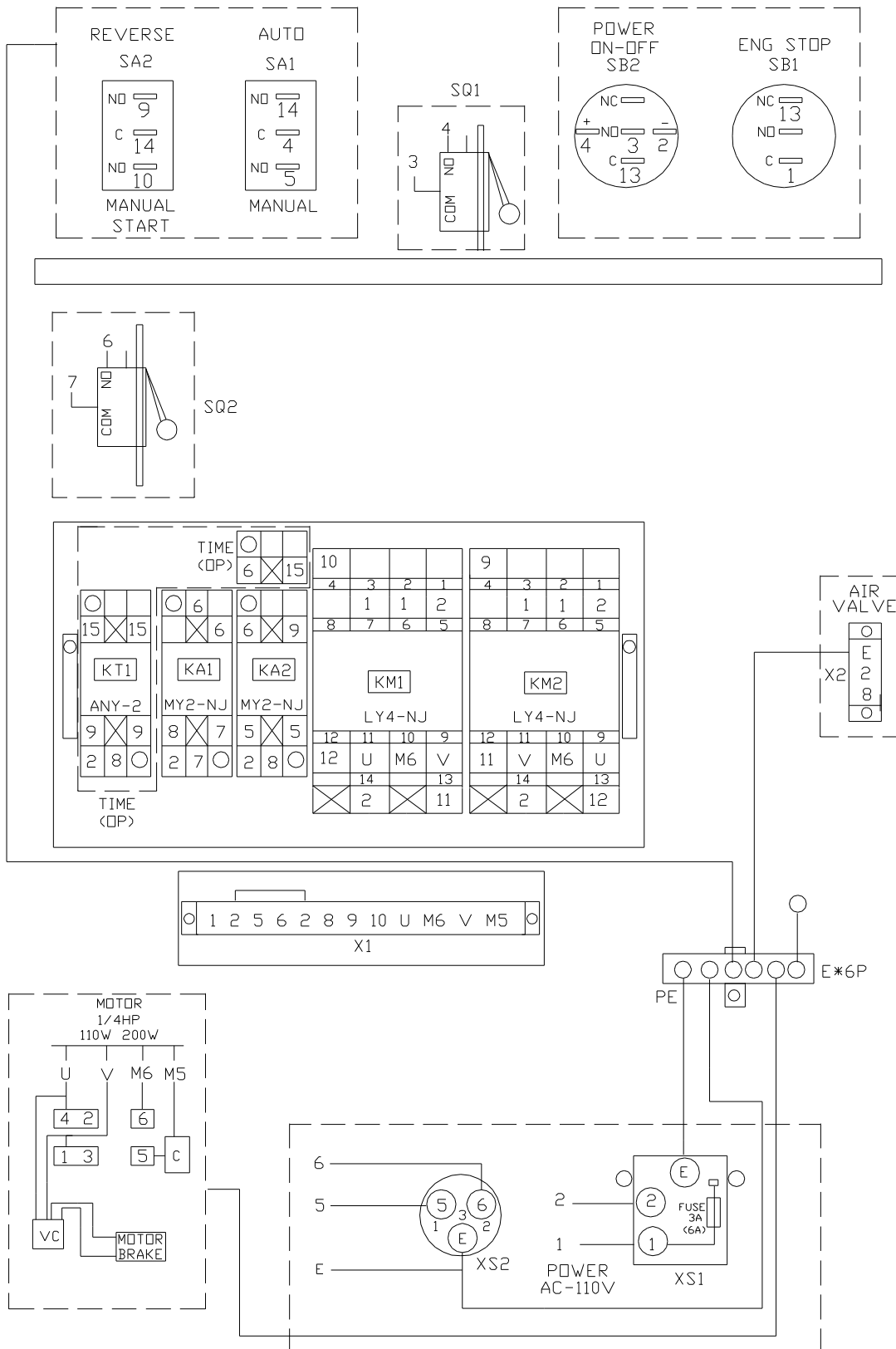

I. Diagram and parts list

After service will request below information:

1. Model number
2. Machine serial number (marked behind on machine)
3. Parts number, name and quantity

① Machine main structure

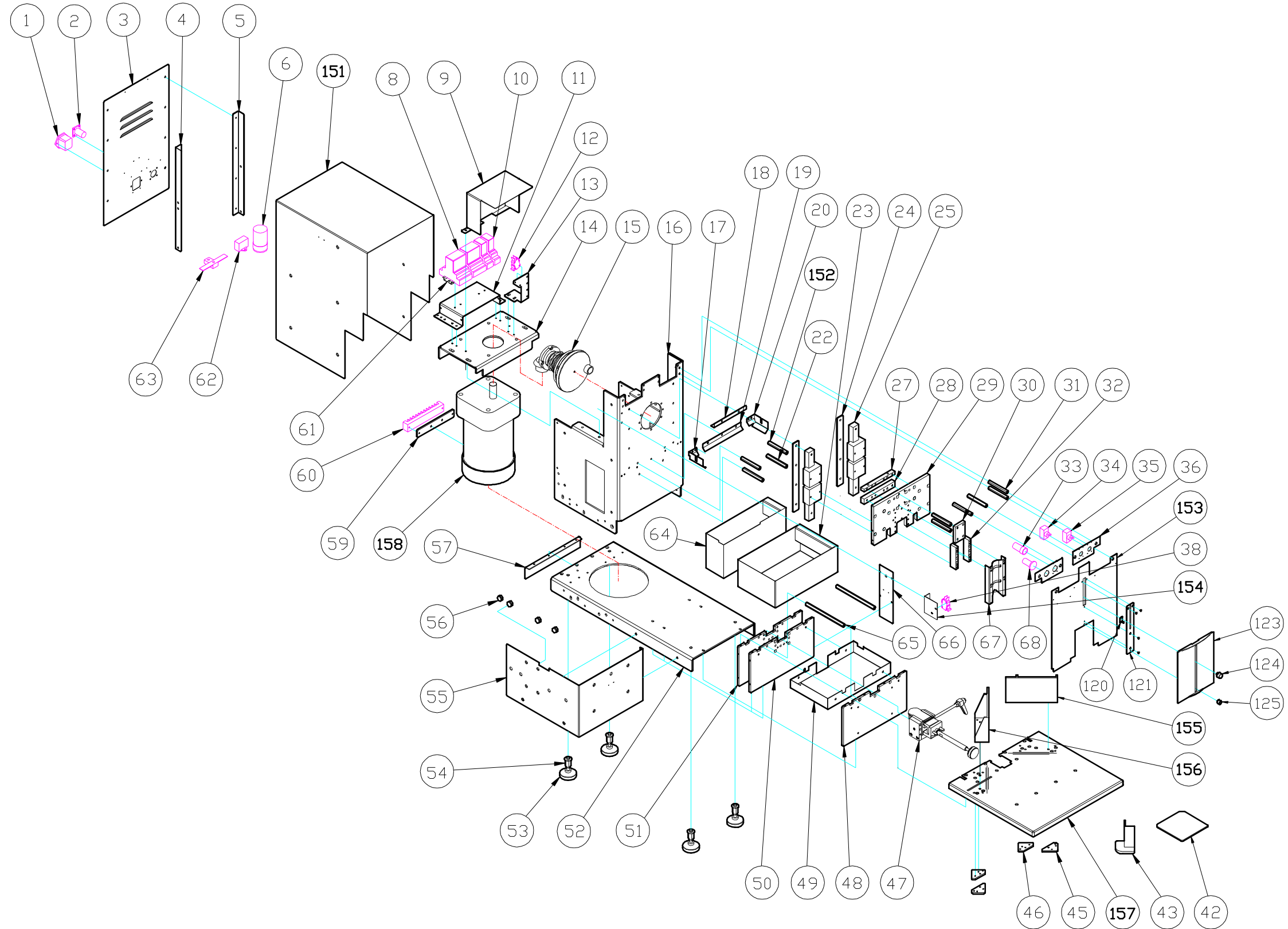

Parts list

No.	Description	Diagram no.	Q'ty	No.	Description	Diagram no.	Q'ty
1	Power socket	#	1	49	Inner shutter	D03-01	1
2	Foot switch socket	#	1	50	Middle structural plate	D05-02	1
3	Back plate	D03-03	1	51	Front structural plate	D05-01	1
4	Right back fixing plate	D03-04	1	52	Main base	D01-01	1
5	Left back fixing plate	D03-05	1	53	Adjustable leg-glides	D01-06	4
6	Condenser	#	1	54	Adjustable nut	D01-08	4
8	Large relay	#	2	55	Left cover	D03-02	1
9	Gear protector cover	D04-08	1	56	Magnet seat	D07-11	4
10	Small relay	#	2	57	Back shutter	D01-10	1
11	Relay base	D04-02	1	59	Terminal blocks seat	D04-09	1
12	Brake limits switch	#	1	60	Terminal blocks	#	1
13	LS fixing plate	D04-01	1	61	Relay guide seat	D04-10	1
14	Motor base	D04-03	1	62	Rectifier	#	1
15	Main shaft system	Followed by details		63	Earth copper plate	#	1
16	Main structural	D02-01-1	1	64	Scrap box	D04-05	1
17	Left scrap plate	D01-03	1	65	Reinforcement axle	D14-09	2
18	Upper scrap plate	D01-02	1	66	Right cover	D03-06	1
19	Middle scrap plate	D01-05	1	67	Upper blade (R6)	D09-11	1
20	Right scrap plate	D01-04	1	68	Emergency stop switch	#	1
22	Lower fixing axle	D14-07	2	120	Slide block	D16-03	1
23	Tool box	D04-06	1	121	Slideway	D16-02	1
24	LG washer	D04-07	2	123	Safety protector	D16-01	1
25	Linear guideway	#	2	124	adjust button	D16-04	1
27	CF upper guide	D07-13	1	125	Location axle	D16-06	1
28	CF lower guide	D07-14	1	151	Outside the shield	D13-01	1
29	Main slide seat	D07-01	1	152	Middle fixing axle	D14-08	2
30	Limiting board	D07-15	1	153	Front plate	D14-02	1
31	Upper fixing axle	D14-06	6	154	Front LS fixing plate	D02-08	1
32	Blade base	D07-08	2	155	Right side guide	D02-05-1	1
33	Power switch	#	1	156	Left side guide	D02-04-1	1
34	Function switch	#	1	157	Standard work desk	D15-01-1	1
35	Manual start switch	#	1	158	Motor (100W)	#	1
36	Control parts plate	D14-01	2				
38	End cover limits switch	#	1				
42	Calibrate gauge	D02-06	1				
43	L guide	D02-07	1				
45	Back pad	D02-02	2				
46	Front pad	D02-03	2				
47	Lower blade system	Followed by details					
48	Back structural plate	D05-03	1				

#" Standard hardware parts

② Parts of structure: Main shaft system and Lower blade system

After service will request below information:
 1. Model number
 2. Machine serial number (marked behind on machine)
 3. Parts number, name and quantity

Main shaft system

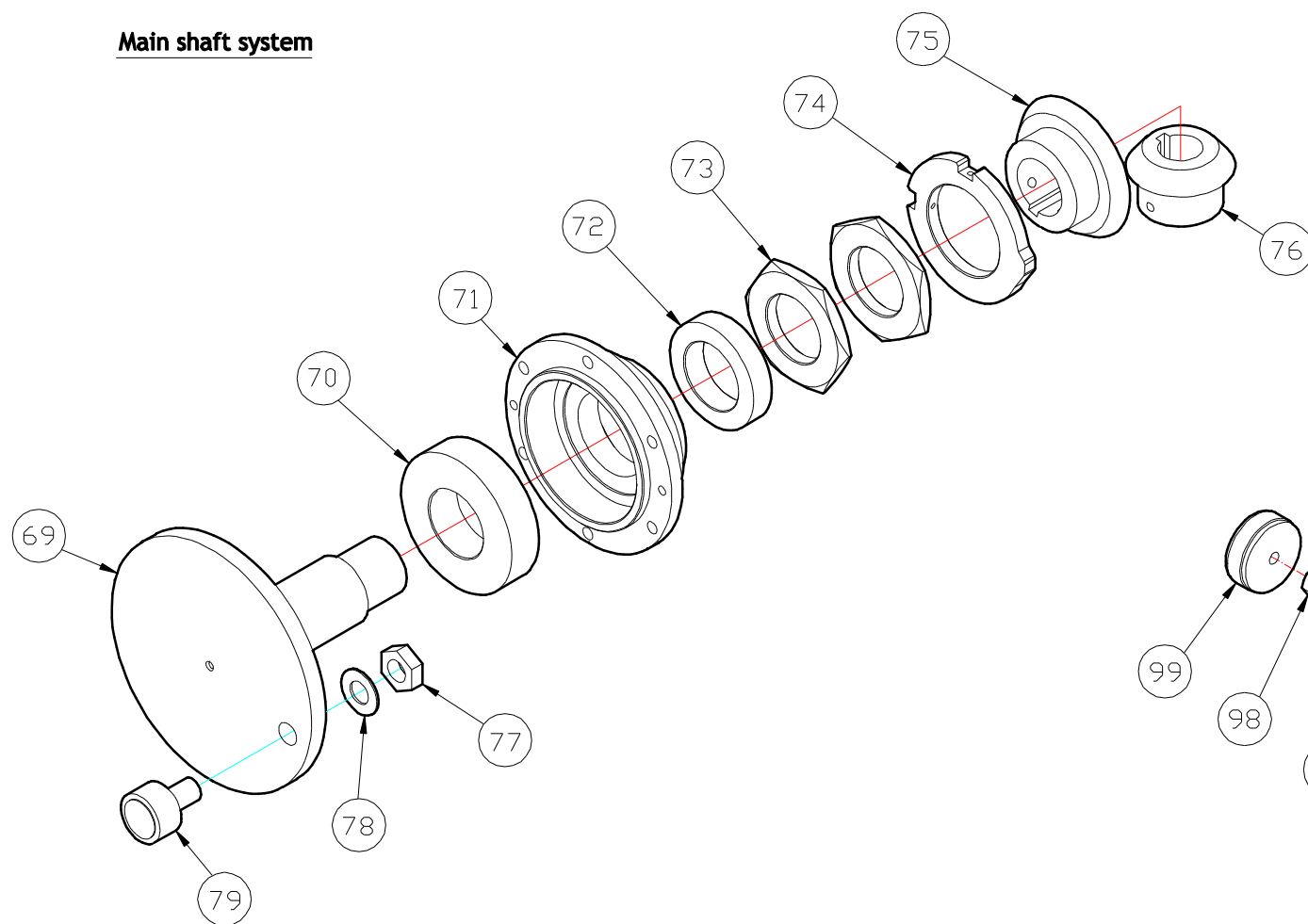

Lower blade system

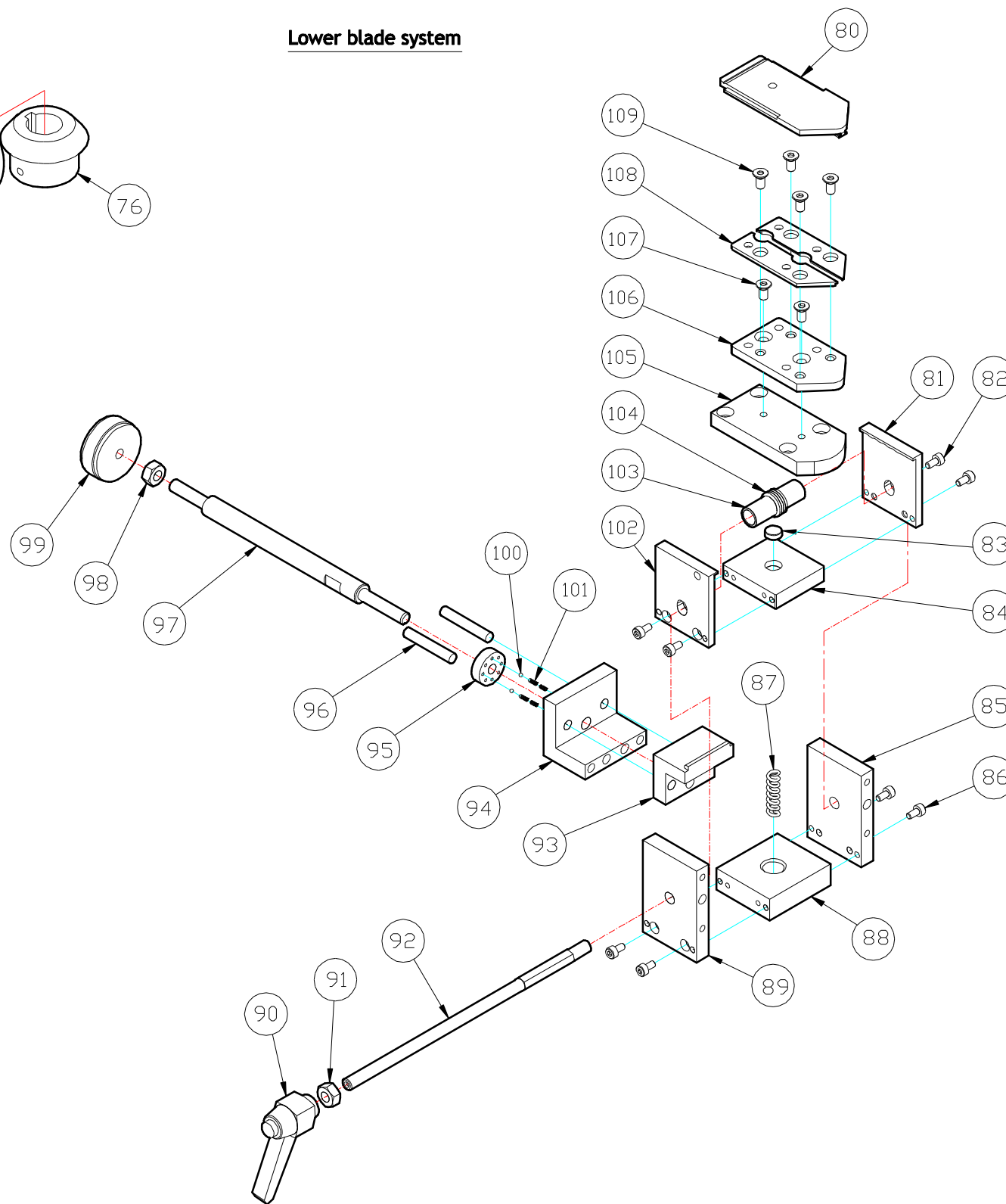

Parts list

No.	Description	Diagram no.	Q'ty	No.	Description	Diagram no.	Q'ty
69	Main shaft	D07-05	1	104	Cam	D06-06	4
70	Angular contact ball bearing	# (7206)	1	105	Baseboard	D05-04	1
71	Main shaft seat	D07-06	1	106	Blade base	D05-13 (R6)	1
72	Thrust bearing	# (51106)	1	107	Setscrew	# (M4X10L)	2
73	Fixing nut	D07-10	2	108	Blade fastening plate	D05-18	2
74	Control ring	D07-09	1	109	Setscrew	# (M4X6L)	4
75	Large bevel gear	D07-16	1				
76	Small bevel gear	D07-18	1				
77	Nut	D07-21	1				
78	Washer	D07-20	1				
79	Cam followers	# (CFH10)	1				
80	Lower blade pad	D05-08 (R6)	1				
81	Left fastening plate	D06-01	1				
82	Setscrew	# (M3X6L)	4				
83	Cam washer	D06-16	1				
84	Cam baseboard	D06-03	1				
85	Left outer plate	D06-04	1				
86	Setscrew	# (M3X10L)	4				
87	Return spring	D06-10-1	1				
88	Baseboard	D06-05	1				
89	Right outer plate	D06-04	1				
90	Locking handle	D06-15	1				
91	Nut	# (M6)	1				
92	Cam shaft	D06-09	1				
93	Push plate	D06-12	1				
94	Feed base	D06-11	1				
95	Positioning plate	D06-14	1				
96	Slideway	D06-17	2				
97	Feed shaft	D06-13	1				
98	Nut	# (M6)	1				
99	Feed knob	D06-08	1				
100	Steel ball	# (Ø3)	4				
101	Spring	MP-19	4				
102	Right fastening plate	D06-02	1				
103	Shrink-ring	D06-07	2				

"#" Standard hardware parts

④ Screws and other standard hardware parts list

No.	Hardware description	Specifications	Q'ty	No.	Hardware description	Specifications	Q'ty
1	Hex flat head screws	M3X10L	2	156	Hex socket head screws	M4X16L	2
2	Hex button head screws	M3X8L	4		Washers	Ø4X2t	2
3	Hex button head screws	M4X8L	8	157	Hex flat head screws	M4X8L	12
4	Hex socket head screws	M4X6L	2	45	Hex flat head screws	M3X10L	4
5	Hex socket head screws	M4X6L	2	46	Hex flat head screws	M3X10L	4
6	Hex socket head screws	M4X6L	2	48	Hex socket head screws	M4X12L	2
151	Hex flat head screws	M4X8L	10	49	Hex socket head screws	M4X6L	4
9	Hex socket head screws	M4X8L	2	50	Hex socket head screws	M4X12L	2
11	Hex socket head screws	M4X8L	4	51	Hex socket head screws	M4X12L	2
12	Cross round head screws	M3X16L	2	54	Washers	Ø8x2t	4
13	Hex socket head screws	M4X6L	2	55	Hex flat head screws	M4X8L	10
14	Hex socket head screws	M6X20L	4	57	Hex flat head screws	M4X8L	4
	Washers	Ø6X2t	4	158	Hex socket head screws	M8X25L	4
	Hex nuts	M6	4		Washers	Ø8x2t	4
16	Hex socket head screws	M5X10L	8		Hex nuts	M8	4
	Location pins	Ø5x10L	2	59	Cross round head screws	13/16" X 3/8" L	2
17	Cross round head screws	M4X8L	2	60	Hex socket head screws	M4X10L	2
18	Hex socket head screws	M4X8L	2	61	Hex socket head screws	M4X8L	2
19	Cross round head screws	M4X8L	3	62	Hex socket head screws	M4X12L	1
20	Cross round head screws	M4X8L	2	63	Hex socket head screws	M5X10L	1
152	Hex socket head screws	M4X12L	2	65	Hex socket head screws	M4X12L	2
22	Hex socket head screws	M4X12L	2		Hex socket head screws	M4X8L	2
25	Hex socket head screws	M5X25L	8	66	Hex flat head screws	M3X10L	4
27	Hex socket head screws	M5X12L	4	67	Hex button head screws	M4X8L	4
	Location pins	Ø5X16L	2	70	Angular contact ball bearing	7206	1
28	Hex socket head screws	M5X12L	4	71	Hex socket head screws	M5X12L	6
	Location pins	Ø5X16L	2		Location pins	Ø4X10L	2
29	Hex socket head screws	M5X10L	8	72	Thrust bearing	51106	1
30	Hex socket head screws	M4X16L	4	74	Hex socket head screws	M3X8L	2
31	Hex socket head screws	M4X12L	6	75	Hex headless screws	M5X8L	2
32	Hex socket head screws	M4X20L	6		Square keys	5X20L	1
	Location pins	Ø3X10L	6	76	Hex socket head screws	M5X8L	2
36	Hex flat head screws	M4X8L	4		Square keys	5X20L	1
153	Hex flat head screws	M4X8L	2	79	Cam followers	CFH10	1
38	Cross round head screws	M3X20L	2	81	Hex socket head screws	M3X8L	2
	Hex nuts	M3	2		Location pins	Ø3X10L	2
154	Hex socket head screws	M4X8L	2	85	Hex socket head screws	M3X12L	2
155	Hex socket head screws	M4X16L	2		Hex socket head screws	M4X8L	2
	Washers	Ø4X2t	2		Hex socket head screws	M4X12L	2

SPECIFICATIONS

Item No.	AD-6					
Four Kinds of Blades	Radius	1/8"	1/4"	3/8"		
	Straight	length 5/8"				
Cutting Capacity	23.6" (600 sheets)					
Cutting Speed	46 rpm					
Dimensions	24.6"(W) X 12.6"(D) X 17.5"(H)					
Weight / Volumn	103 lbs / 3.14 CbFt					
Power	110vac	Single-Phase (50-60Hz)				
Motor	100 W					